

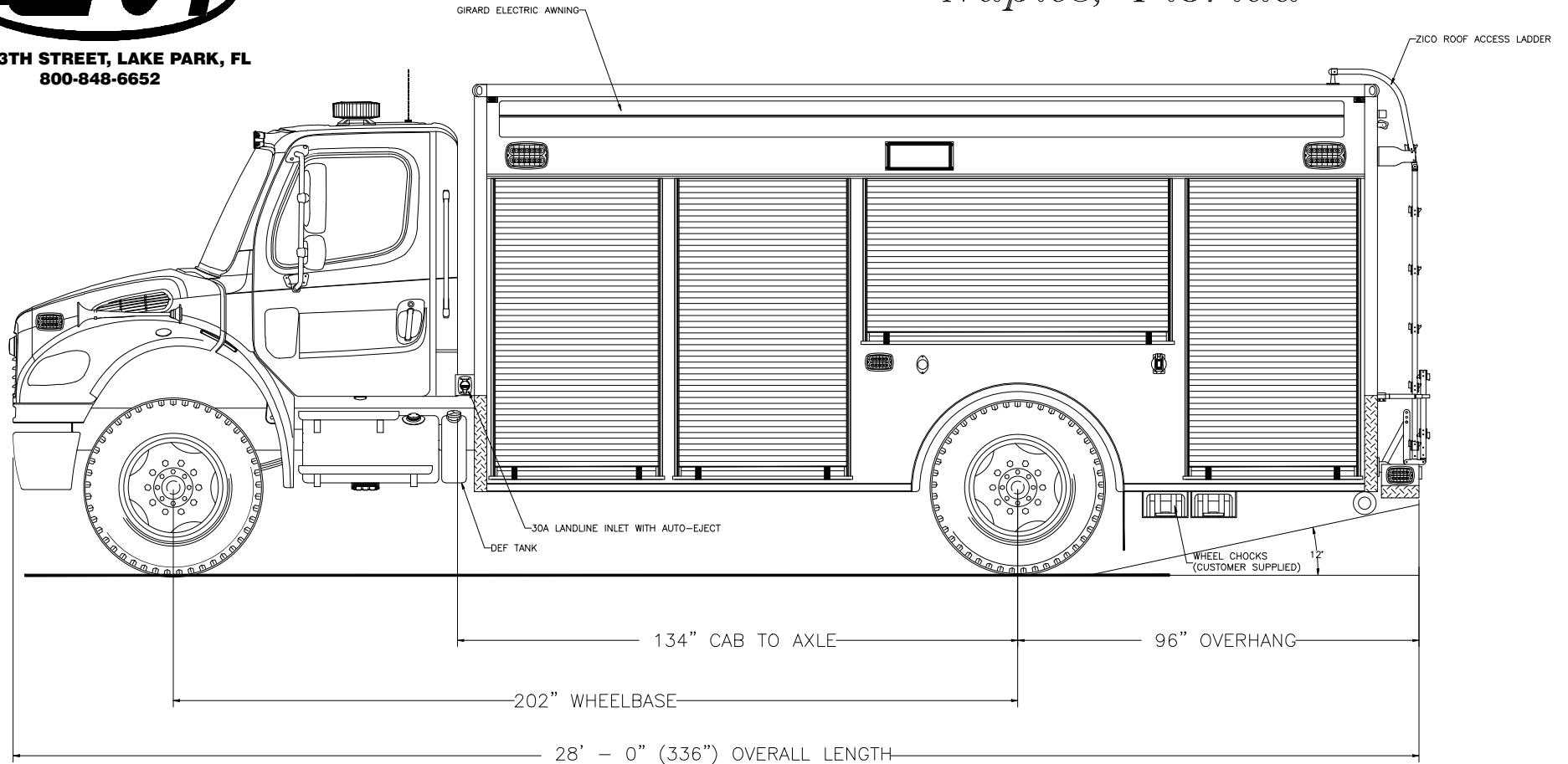

705 13TH STREET, LAKE PARK, FL
800-848-6652

*Greater Naples Fire Rescue Dist.
Naples, Florida*



***NOTE: 3/16" (.188") SKINS TO BE USED**

Streetside Overall

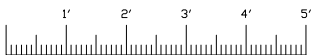

THESE DESIGN/ENGINEERING DRAWING(S) ARE THE PROPERTY OF EMERGENCY VEHICLES, INC. THEY ARE PROPRIETARY, AND ARE FOR THE EXCLUSIVE USE OF YOUR ENTITY. ANY DIVULGING OF THIS DATA TO A THIRD PARTY IS PROHIBITED.

<i>E. J. ...</i> DATE: 02/10/15	
REVISION 1	ACS - 04/27/15
REVISION 2	-
REVISION 3	-
REVISION 4	-
REVISION 5	-



705 13TH STREET, LAKE PARK, FL
800-848-6652

Greater Naples Fire Rescue Dist. Naples, Florida

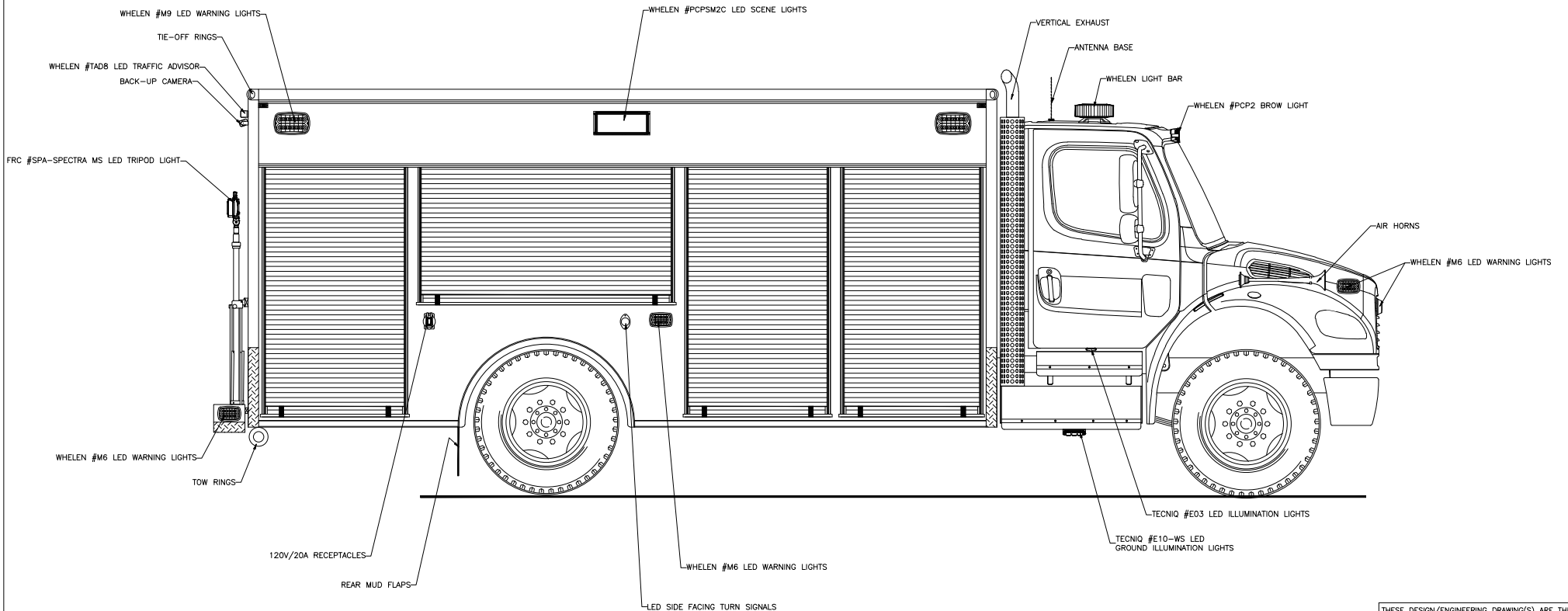

***NOTE: 3/16" (.188") SKINS TO BE USED**

Curbside Overall

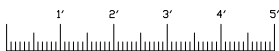

THESE DESIGN/ENGINEERING DRAWING(S) ARE THE PROPERTY OF EMERGENCY VEHICLES, INC. THEY ARE PROPRIETARY, AND ARE FOR THE EXCLUSIVE USE OF YOUR ENTITY. ANY DIVULGING OF THIS DATA TO A THIRD PARTY IS PROHIBITED.

		DATE: 02/10/15
REVISION 1	ACS	04/27/15
REVISION 2	-	-
REVISION 3	-	-
REVISION 4	-	-
REVISION 5	-	-



705 13TH STREET, LAKE PARK, FL
800-848-6652

Greater Naples Fire Rescue Dist.
Naples, Florida

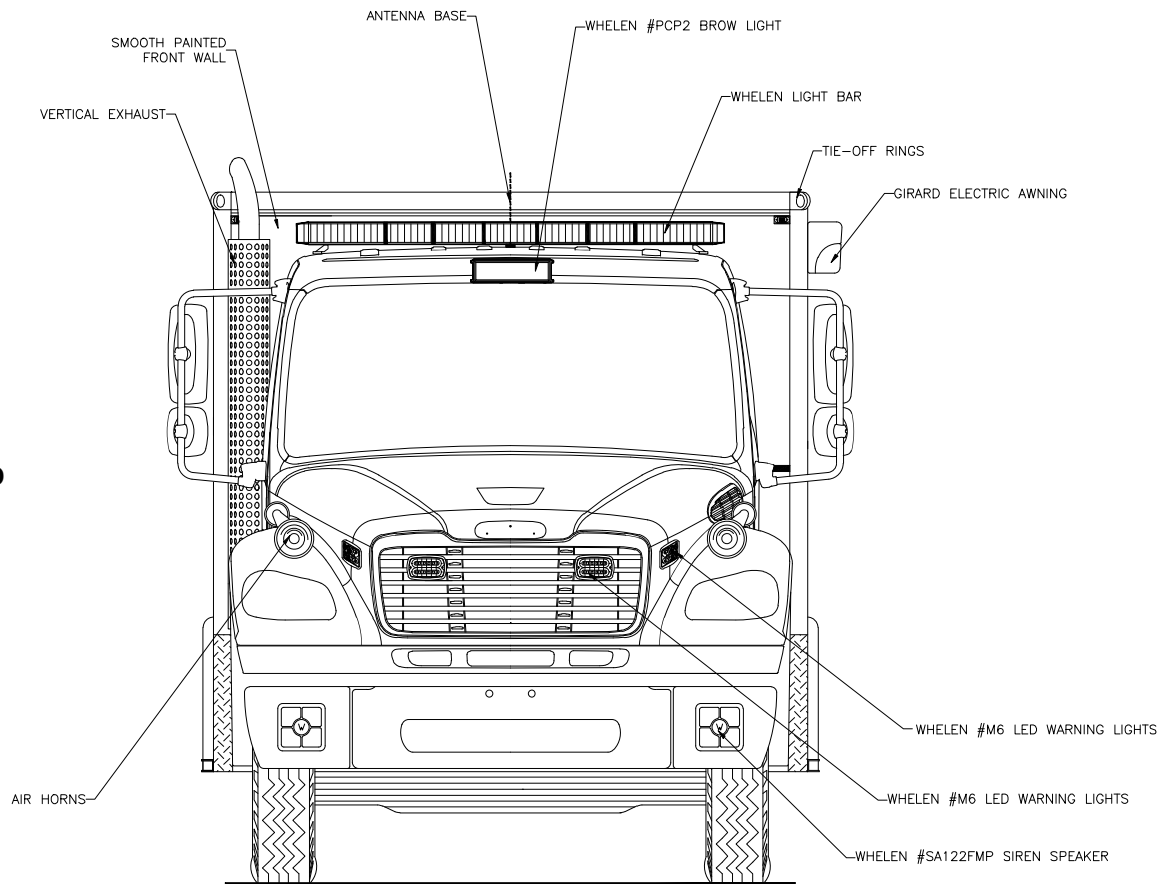

NOTE:
3/16" (.188") SKINS TO BE USED

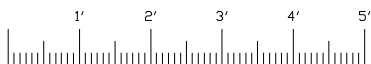

Front View

THESE DESIGN/ENGINEERING DRAWING(S) ARE THE PROPERTY OF EMERGENCY VEHICLES, INC. THEY ARE PROPRIETARY, AND ARE FOR THE EXCLUSIVE USE OF YOUR ENTITY. ANY DIVULGING OF THIS DATA TO A THIRD PARTY IS PROHIBITED.

		DATE: 02/10/15
REVISION 1	ACS	04/27/15
REVISION 2	-	-
REVISION 3	-	-
REVISION 4	-	-
REVISION 5	-	-



705 13TH STREET, LAKE PARK, FL
800-848-6652

Greater Naples Fire Rescue Dist. Naples, Florida

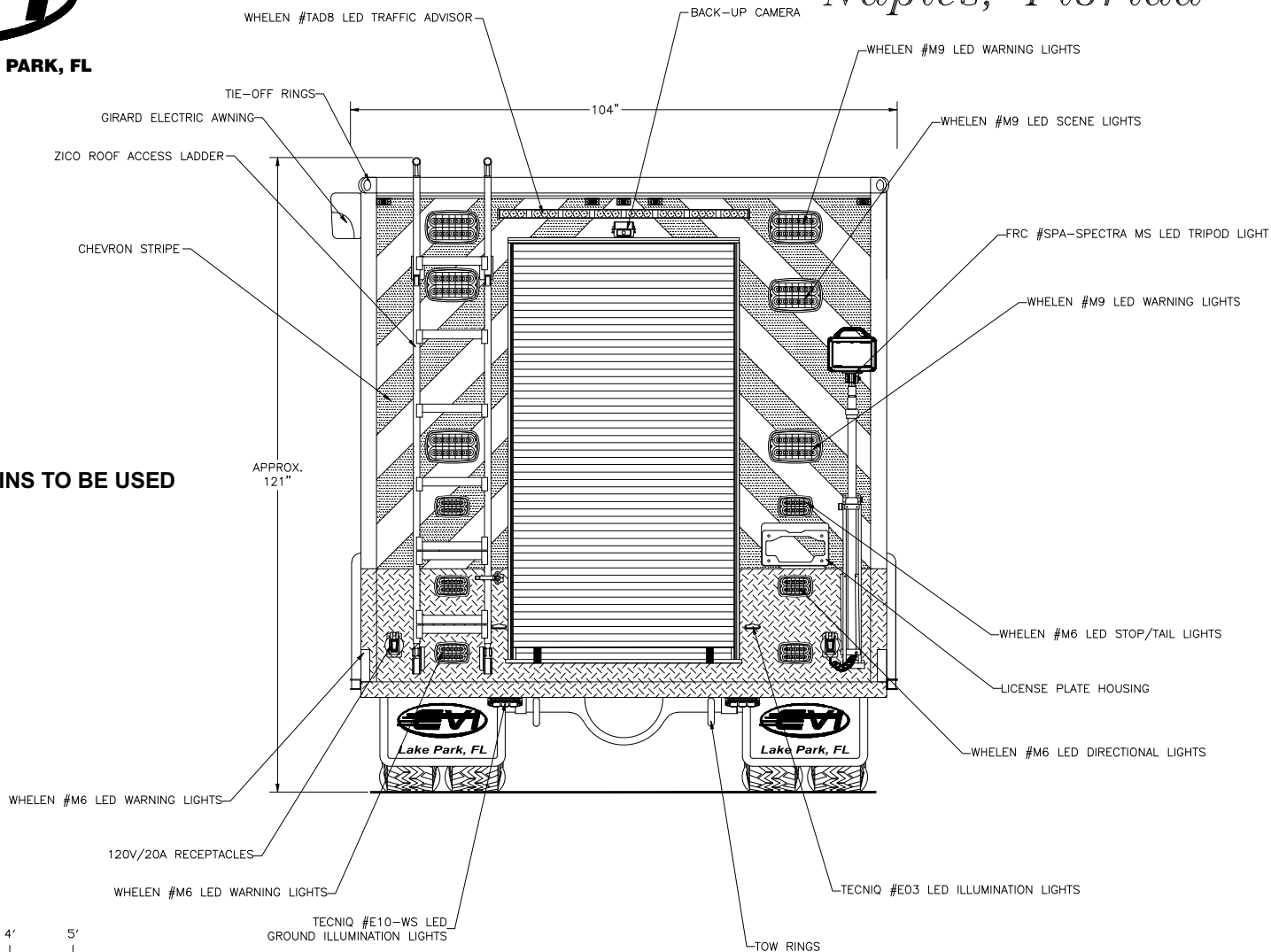

NOTE:
3/16" (.188") SKINS TO BE USED



Rear View

THESE DESIGN/ENGINEERING DRAWING(S) ARE THE PROPERTY OF EMERGENCY VEHICLES, INC. THEY ARE PROPRIETARY, AND ARE FOR THE EXCLUSIVE USE OF YOUR ENTITY. ANY DIVULGING OF THIS DATA TO A THIRD PARTY IS PROHIBITED.

DATE:	02/10/15
REVISION 1	ACS - 04/27/15
REVISION 2	-
REVISION 3	-
REVISION 4	-
REVISION 5	-