

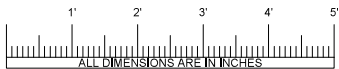

705 13TH STREET, LAKE PARK, FL
800-848-6652

Fargo Fire Department
Fargo, North Dakota

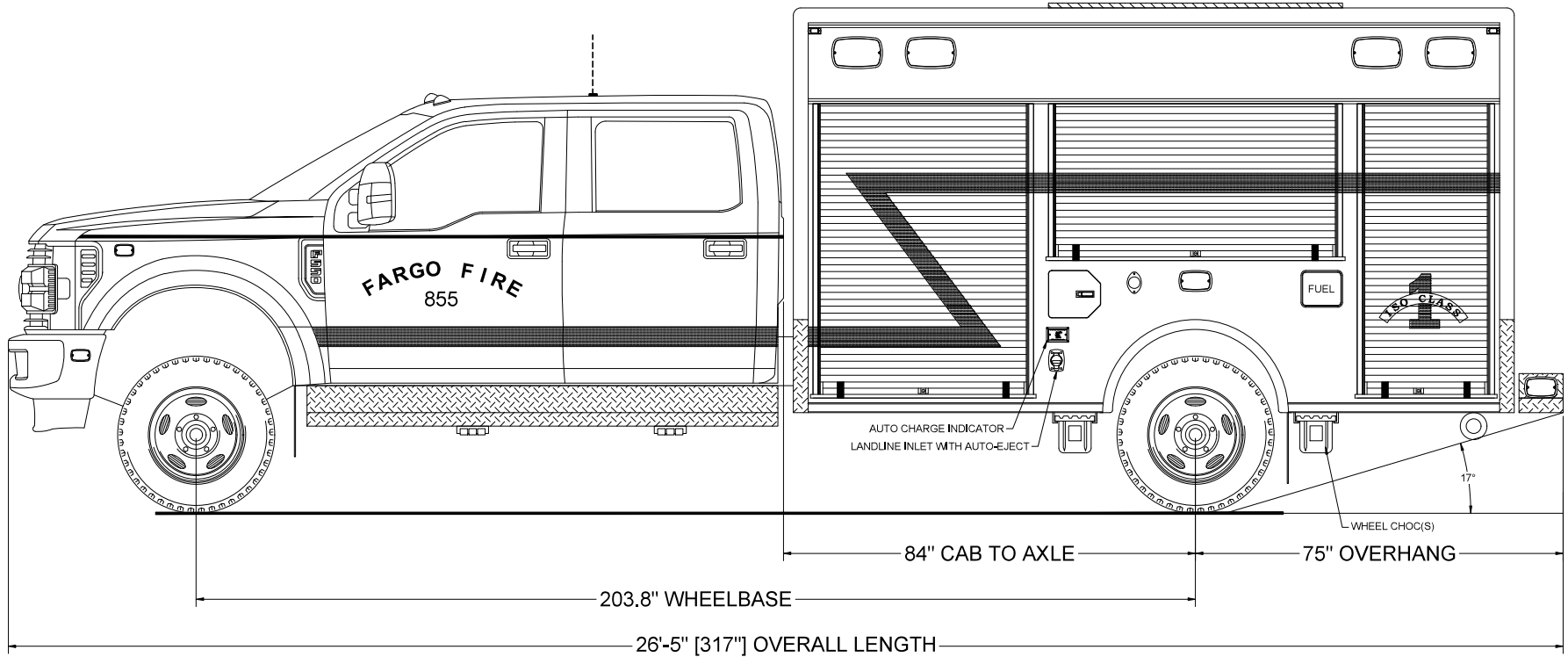

Streetside Overall

NOTICE
THIS DRAWING IS A REPRESENTATION OF THE VEHICLE AND/OR COMPONENTS AS DESCRIBED IN THE SPECIFICATIONS PER THE DATE SHOWN. EVI RESERVES THE RIGHT TO MAKE CHANGES, AS NECESSARY, DURING THE PRODUCTION PROCESS TO ACCOMMODATE BEST MANUFACTURING PROCESSES AND TO ENSURE WE PROVIDE A CONSISTENTLY HIGH QUALITY PRODUCT.

REVISION 1	JPG - 09/23/21	THESE DESKTOP ENGINEERING DRAWINGS(S) ARE THE PROPERTY OF EMERGENCY VEHICLES, INC. THEY ARE PROPRIETARY, AND ARE FOR THE EXCLUSIVE USE OF YOUR ENTITY. ANY DUPLICATION OF THIS DATA TO ANY PARTY IS PROHIBITED.
REVISION 2	JPG - 01/12/22	
REVISION 3	NS - 01/21/22	
REVISION 4	NS - 04/01/22	
REVISION 5	-	
REVISION 6	-	

DATE 01/12/22

PRODDWG\3126_FARGO_ND\3126_12NW\NS\052721



705 13TH STREET, LAKE PARK, FL
800-848-6652

Fargo Fire Department Fargo, North Dakota

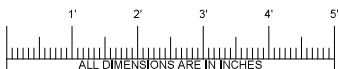
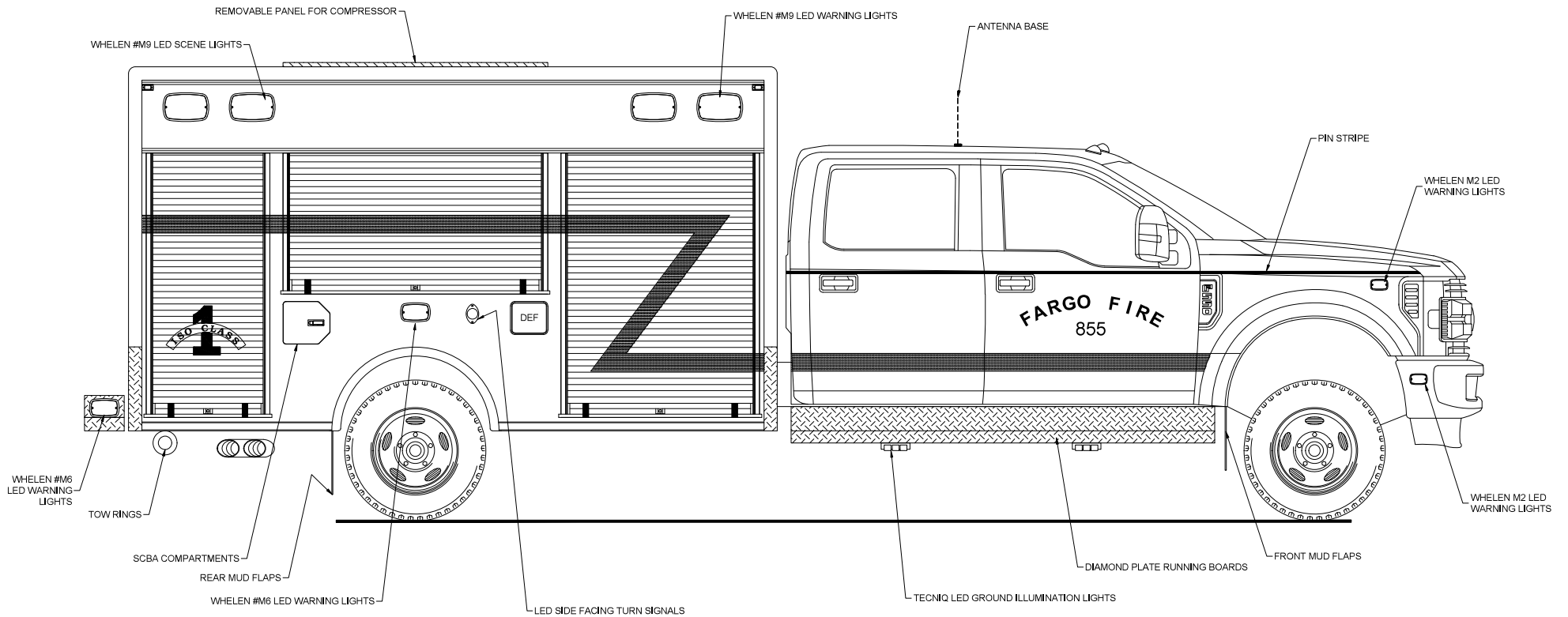

Curbside Overall

NOTICE

THIS DRAWING IS A REPRESENTATION OF THE VEHICLE AND/OR COMPONENTS AS DESCRIBED IN THE SPECIFICATIONS PER THE DATE SHOWN. EVI RESERVES THE RIGHT TO MAKE CHANGES, AS NECESSARY, DURING THE PRODUCTION PROCESS TO ACCOMMODATE BEST MANUFACTURING PROCESSES AND TO ENSURE WE PROVIDE A CONSISTENTLY HIGH QUALITY PRODUCT.

REVISION 1	JPG	09/23/21
REVISION 2	JPG	01/12/22
REVISION 3	NS	01/21/22
REVISION 4	NS	04/01/22
REVISION 5	-	-
REVISION 6	-	-

THESE DESIGN/ENGINEERING DRAWINGS ARE THE PROPERTY OF EMERGENCY VEHICLES, INC. THEY ARE PROPRIETARY AND ARE FOR THE EXCLUSIVE USE OF YOUR ENTITY. ANY DIVULGING OF THIS DATA TO A THIRD PARTY IS PROHIBITED.

DATE: 01/12/22



705 13TH STREET, LAKE PARK, FL
800-848-6652

Fargo Fire Department Fargo, North Dakota

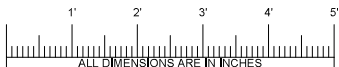
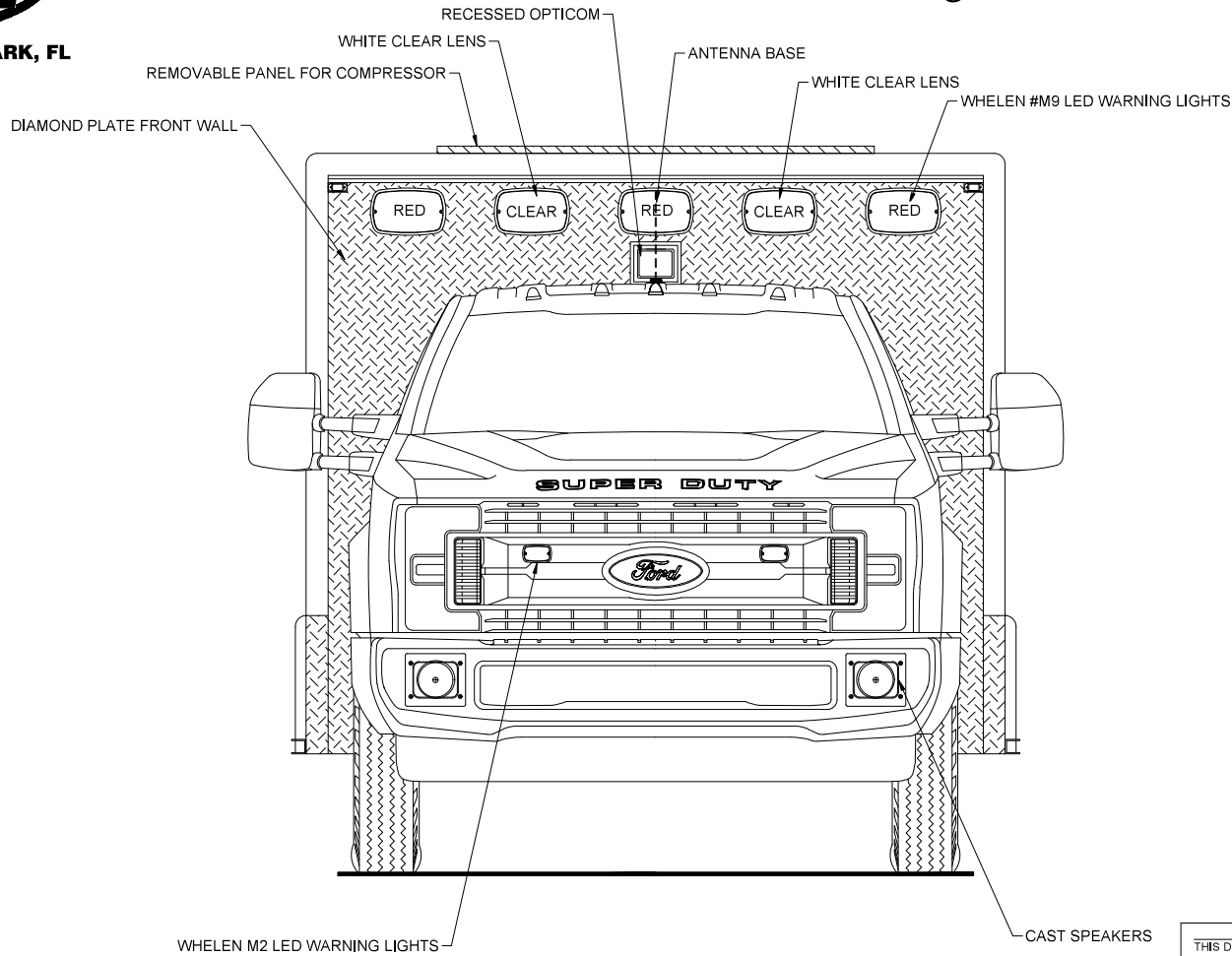

Front View

NOTICE

THIS DRAWING IS A REPRESENTATION OF THE VEHICLE AND/OR COMPONENTS AS DESCRIBED IN THE SPECIFICATIONS PER THE DATE SHOWN. EVI RESERVES THE RIGHT TO MAKE CHANGES, AS NECESSARY, DURING THE PRODUCTION PROCESS TO ACCOMMODATE BEST MANUFACTURING PROCESSES AND TO ENSURE WE PROVIDE A CONSISTENTLY HIGH QUALITY PRODUCT.

REVISION 1	JPG	09/23/21
REVISION 2	JPG	01/12/22
REVISION 3	NS	01/21/22
REVISION 4	NS	04/01/22
REVISION 5	-	-
REVISION 6	-	-

THESE DESIGN/ENGINEERING DRAWING(S) ARE THE PROPERTY OF EMERGENCY VEHICLES, INC. THEY ARE PROPRIETARY, AND ARE FOR THE EXCLUSIVE USE OF YOUR ENTITY. ANY DIVULGING OF THIS DATA TO ANY OTHER PARTY IS PROHIBITED.

[Signature] DATE 01/12/22



705 13TH STREET, LAKE PARK, FL
800-848-6652

Fargo Fire Department Fargo, North Dakota

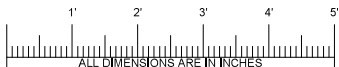
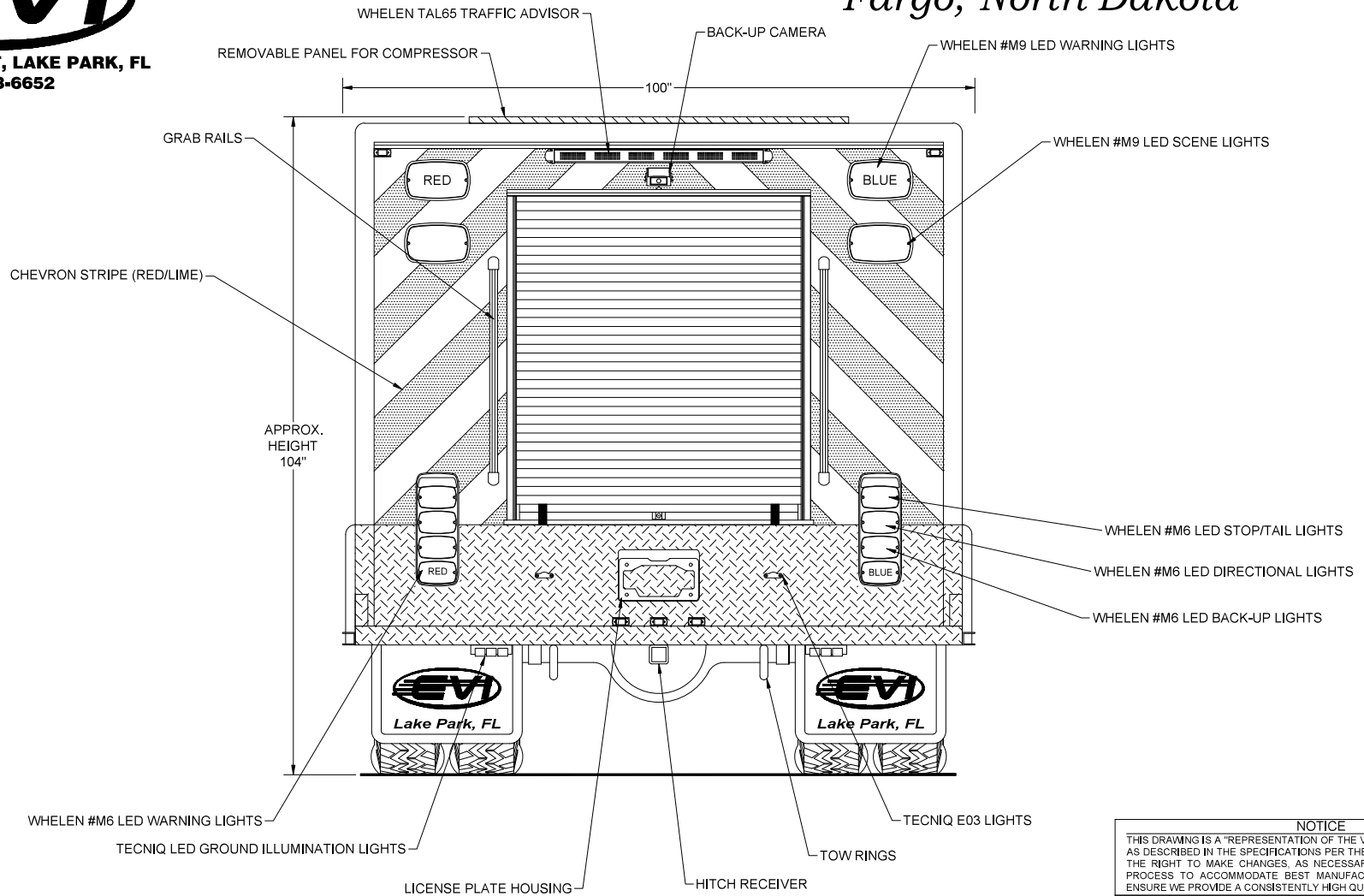

Rear View

NOTICE

THIS DRAWING IS A REPRESENTATION OF THE VEHICLE AND/OR COMPONENTS AS DESCRIBED IN THE SPECIFICATIONS PER THE DATE SHOWN. EVI RESERVES THE RIGHT TO MAKE CHANGES, AS NECESSARY, DURING THE PRODUCTION PROCESS TO ACCOMMODATE BEST MANUFACTURING PROCESSES AND TO ENSURE WE PROVIDE A CONSISTENTLY HIGH QUALITY PRODUCT.

REVISION 1	JPG	09/23/21
REVISION 2	JPG	01/12/22
REVISION 3	NS	01/21/22
REVISION 4	NS	04/01/22
REVISION 5	-	-
REVISION 6	-	-

THESE DESIGN/ENGINEERING DRAWINGS ARE THE PROPERTY OF EMERGENCY VEHICLES, INC. THEY ARE PROPRIETARY, AND ARE FOR THE EXCLUSIVE USE OF YOUR ENTITY. ANY DIVULGING OF THIS DATA TO ANY OTHER PARTY IS PROHIBITED.

[Signature] DATE 01/12/22