

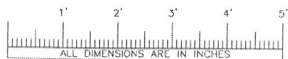

705 13TH STREET, LAKE PARK, FL  
800-848-6652

Monroe County Sheriff's Department  
Monroe County, New York

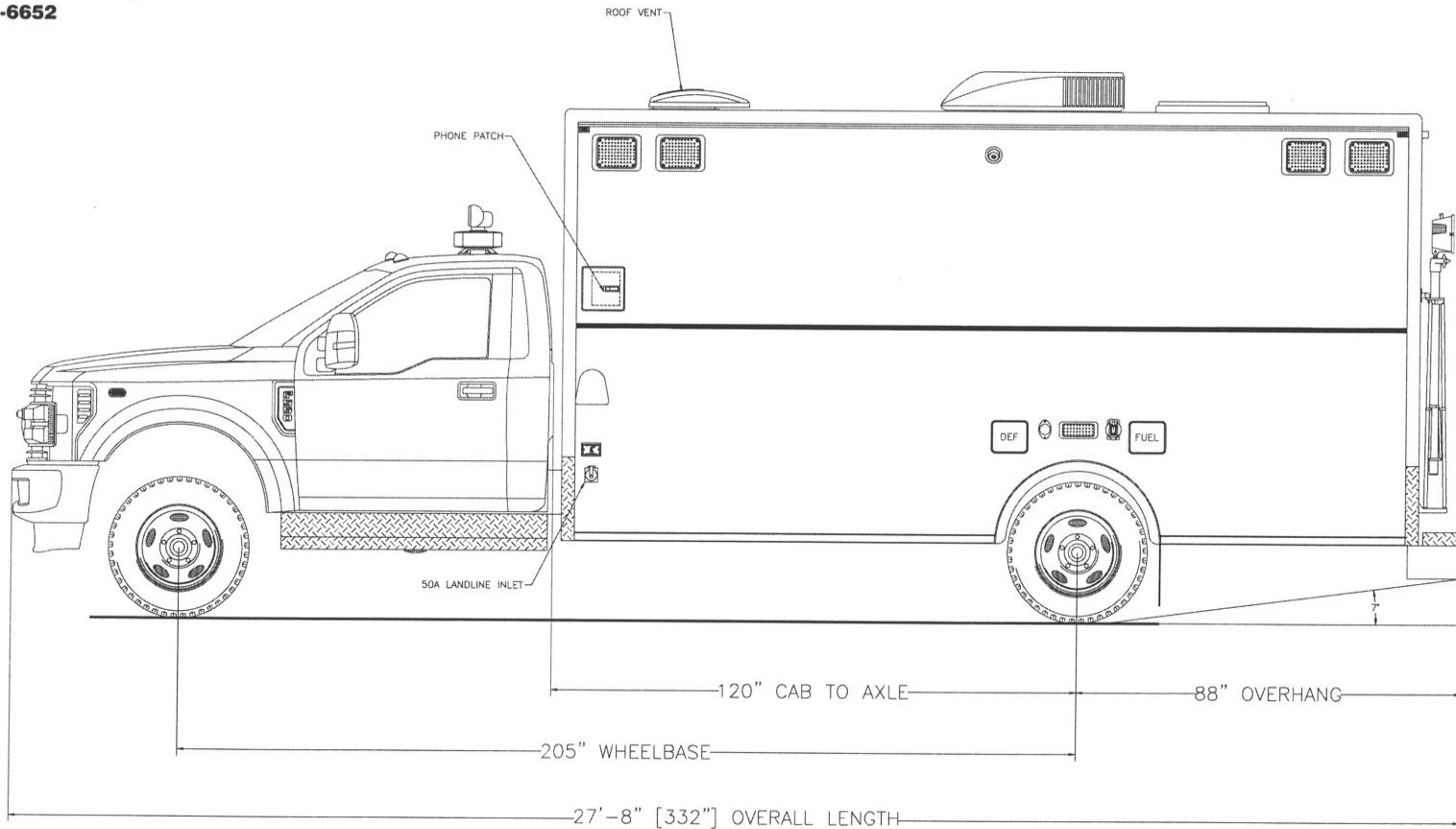

Streetside Overall

THESE DESIGN/ENGINEERING DRAWING(S) ARE THE PROPERTY OF EMERGENCY VEHICLES, INC. THEY ARE PROPRIETARY, AND ARE FOR THE EXCLUSIVE USE OF YOUR ENTITY. ANY DIVULGING OF THIS DATA TO A THIRD PARTY IS PROHIBITED.

*[Signature]* DATE: 09/18/18

REVISION 1	BL - 01/17/19
REVISION 2	-
REVISION 3	-
REVISION 4	-
REVISION 5	-



705 13TH STREET, LAKE PARK, FL  
800-848-6652

# Monroe County Sheriff's Department Monroe County, New York

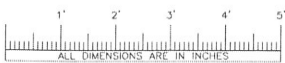
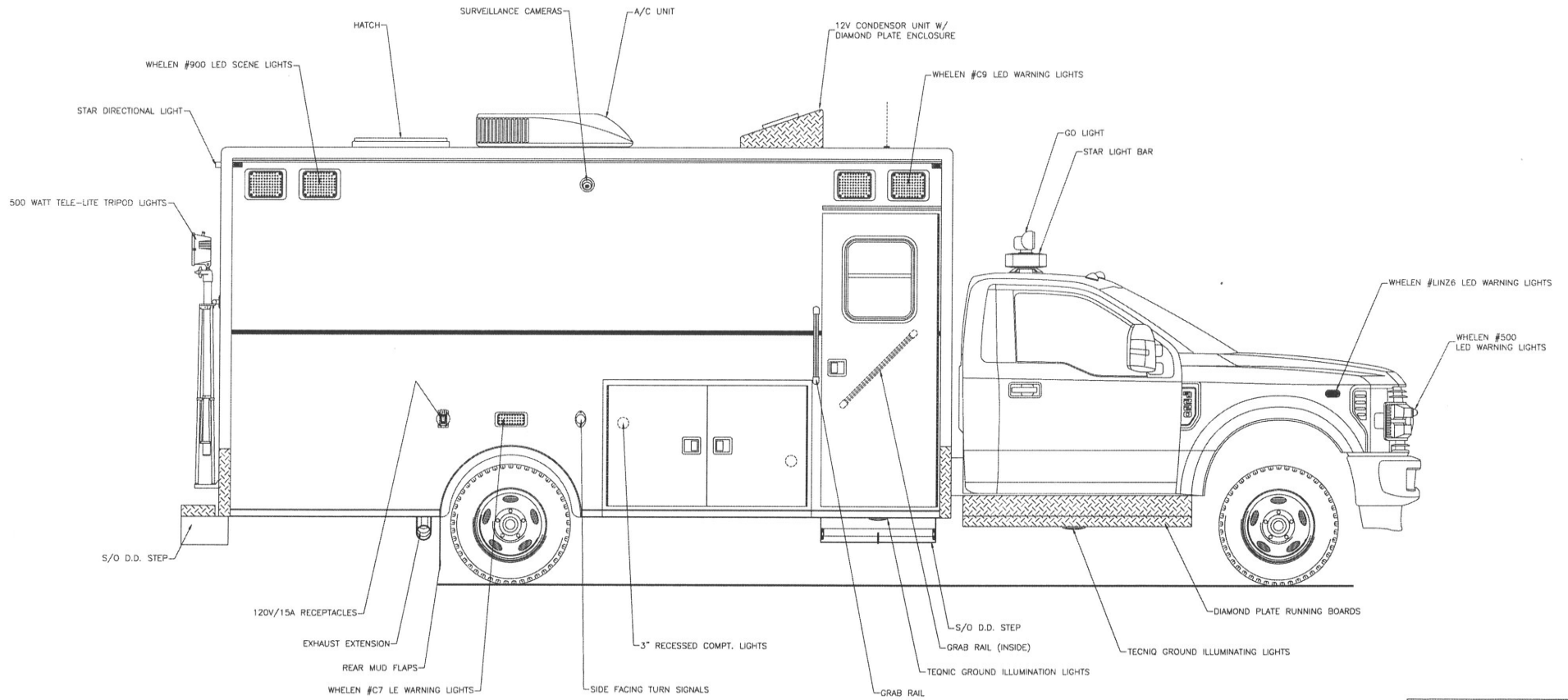

## Curbside Overall

THESE DESIGN/ENGINEERING DRAWING(S) ARE THE PROPERTY OF EMERGENCY VEHICLES, INC. THEY ARE PROPRIETARY, AND ARE FOR THE EXCLUSIVE USE OF YOUR ENTITY. ANY DIVULGING OF THIS DATA TO A THIRD PARTY IS PROHIBITED.

*E. Evans* DATE: 09/18/18

REVISION 1	BL - 01/17/19
REVISION 2	-
REVISION 3	-
REVISION 4	-
REVISION 5	-



705 13TH STREET, LAKE PARK, FL  
800-848-6652

# Monroe County Sheriff's Department Monroe County, New York

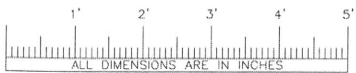
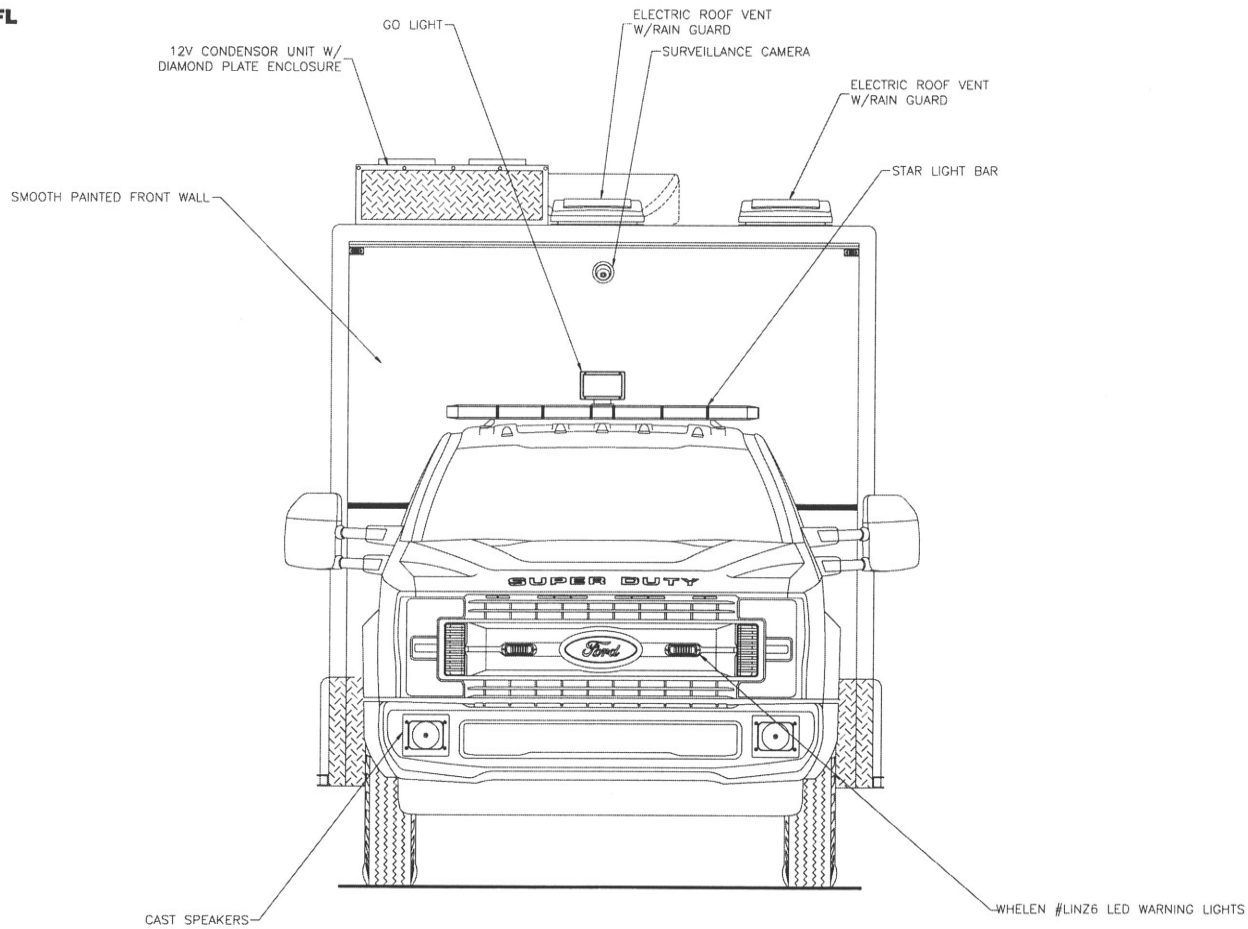

Front View

THESE DESIGN/ENGINEERING DRAWING(S) ARE THE PROPERTY OF EMERGENCY VEHICLES, INC. THEY ARE PROPRIETARY, AND ARE FOR THE EXCLUSIVE USE OF YOUR ENTITY. ANY DIVULGING OF THIS DATA TO A THIRD PARTY IS PROHIBITED.

*E. J. [Signature]* DATE: 09/18/18

REVISION 1	EL - 01/17/19
REVISION 2	-
REVISION 3	-
REVISION 4	-
REVISION 5	-



705 13TH STREET, LAKE PARK, FL  
800-848-6652

# Monroe County Sheriff's Department Monroe County, New York

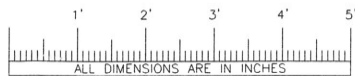
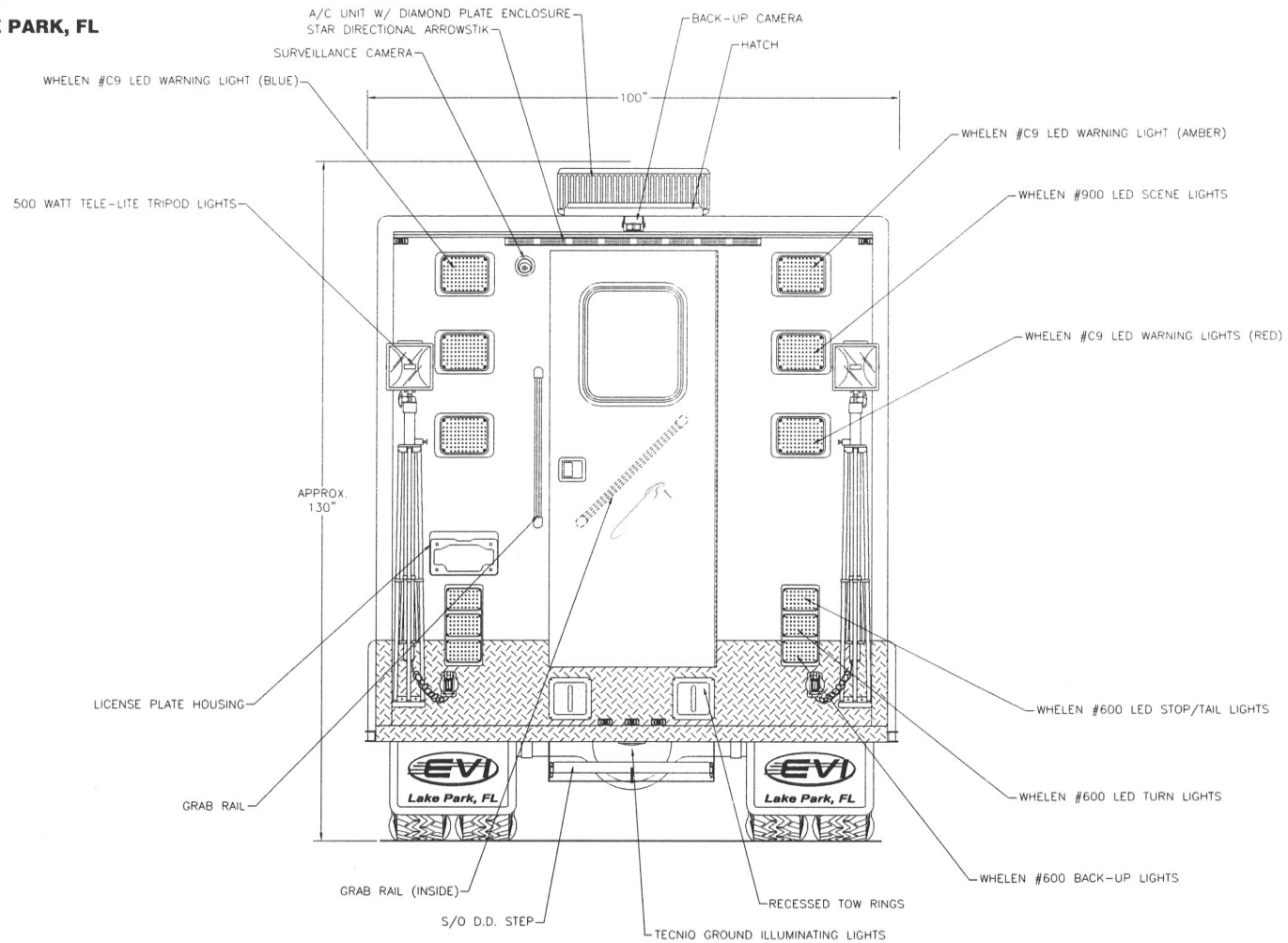

Rear View

THESE DESIGN/ENGINEERING DRAWING(S) ARE THE PROPERTY OF EMERGENCY VEHICLES, INC. THEY ARE PROPRIETARY, AND ARE FOR THE EXCLUSIVE USE OF YOUR ENTITY. ANY DIVULGING OF THIS DATA TO A THIRD PARTY IS PROHIBITED.

*EJ* DATE: 09/18/18

REVISION 1	BL - 01/17/19
REVISION 2	BL - 02/15/19
REVISION 3	-
REVISION 4	-
REVISION 5	-